

All dimensions are in millimeters (mm)

Alignment Key  
Front View

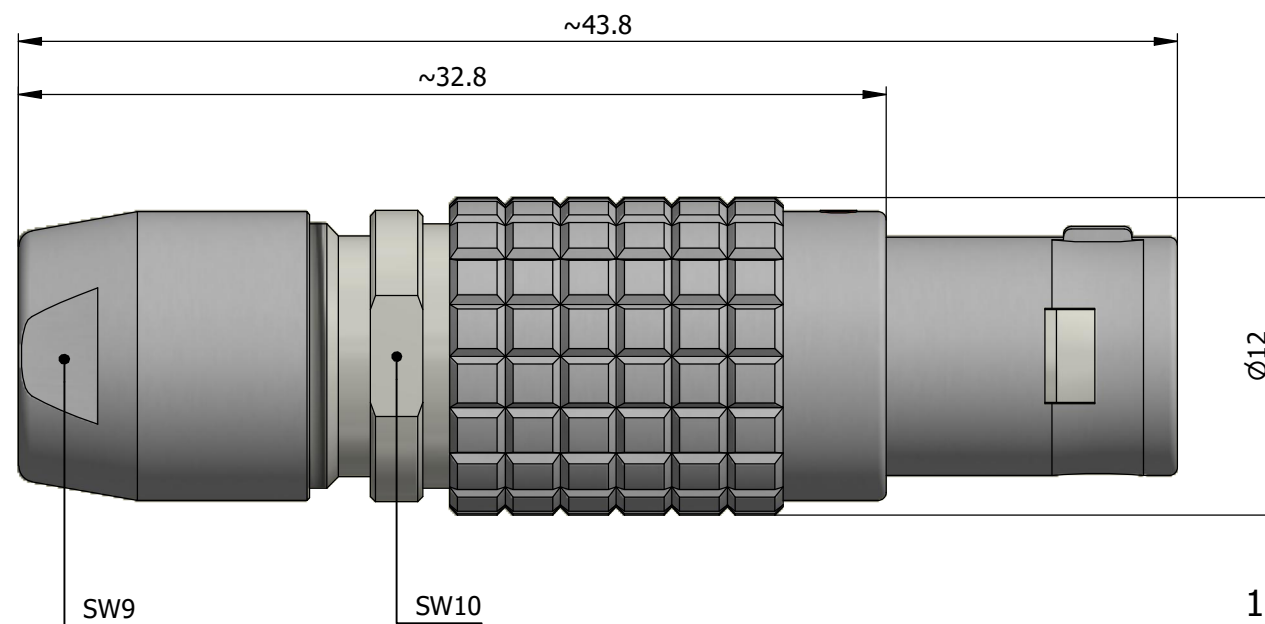

Insert Configuration  
Rear View

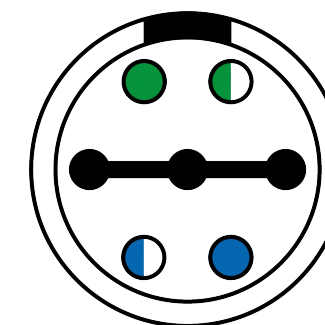

**Note:**

1) This picture is generic and for illustrative purposes only, and may show different keying, materials, colour, finish, and contact configuration. Minor shape or feature variations to actual item may be present.

All additional information are documented on the datasheet (See below link or QR Code)  
[www.lemo.com/pdf/FGG.1B.512.CTAD42.pdf](http://www.lemo.com/pdf/FGG.1B.512.CTAD42.pdf)

Model	Alignment Key	Series	Insert Config.	Housing	Insulator	Contact	Collet Type	Cable Ø	Variant
FGG.1B.512.CTAD42									

<p>Datasheet</p>	<p><b>Straight plug, cable collet</b></p> <p>Series 1B</p>		<p>Drawn 11.10.2021 MARI/OBAR</p>
			<p>Checked 22.01.2026 OBAR</p>
			<p>Modified 03 22.01.2026/MARI</p>
			<p>DO NOT SCALE DRAWING</p>
<p>LEMO SA Chemin des Champs-Courbes 28 1024 Ecublens - SWITZERLAND</p>		<p>Tel. (+41 21) 695 16 00 email : info@lemo.com www.lemo.com</p>	<p>CD</p>
			<p><b>FGG.1B.512.CTAD42</b></p>