

All dimensions are in millimeters (mm)

Alignment Key  
Front View

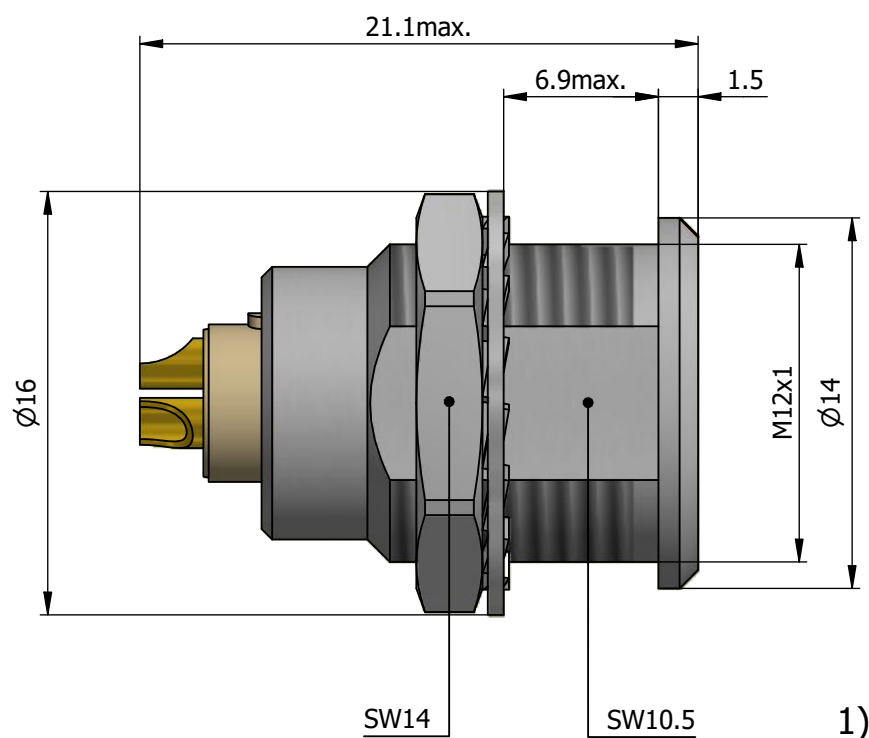

Insert Configuration  
Rear View

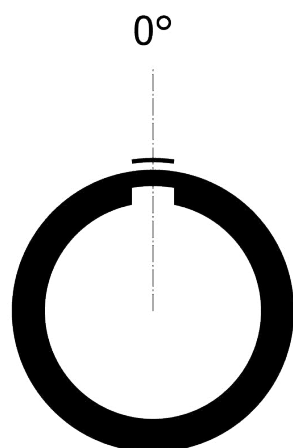
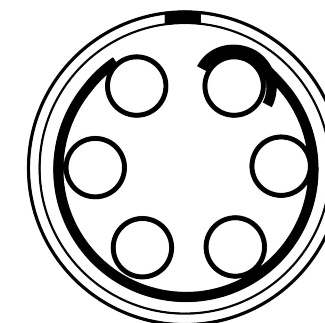

Recommended Panel Cut-Out

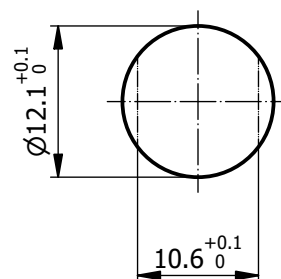

Mounting nut torque (Nm)  
Metal shell = 4.5  
Plastic shell = 0.7

**Note:**

1) This picture is generic and for illustrative purposes only, and may show different keying, materials, colour, finish, and contact configuration. Minor shape or feature variations to actual item may be present.

All additional information are documented on the datasheet (See below link or QR Code)  
[www.lemo.com/pdf/EGG.1B.306.CLL.pdf](http://www.lemo.com/pdf/EGG.1B.306.CLL.pdf)

Model Alignment Key Series Insert Config. Housing Insulator Contact Variant  
EGG.1B.306.CLL

Datasheet



**Fixed socket, nut fixing**

Series 1B

**LEMO**  
LEMO SA  
Chemin des Champs-Courbes 28  
1024 Ecublens - SWITZERLAND

Tel. (+41 21) 695 16 00  
email : info@lemo.com  
www.lemo.com

CD

Drawn	02.12.2014	OVU / JPBA
Checked	09.02.2022	OBAR
Modified	01	09.02.2022 / MARI
DO NOT SCALE DRAWING		

**EGG.1B.306.CLL**