

All dimensions are in millimeters (mm)

Alignment Key
Front View

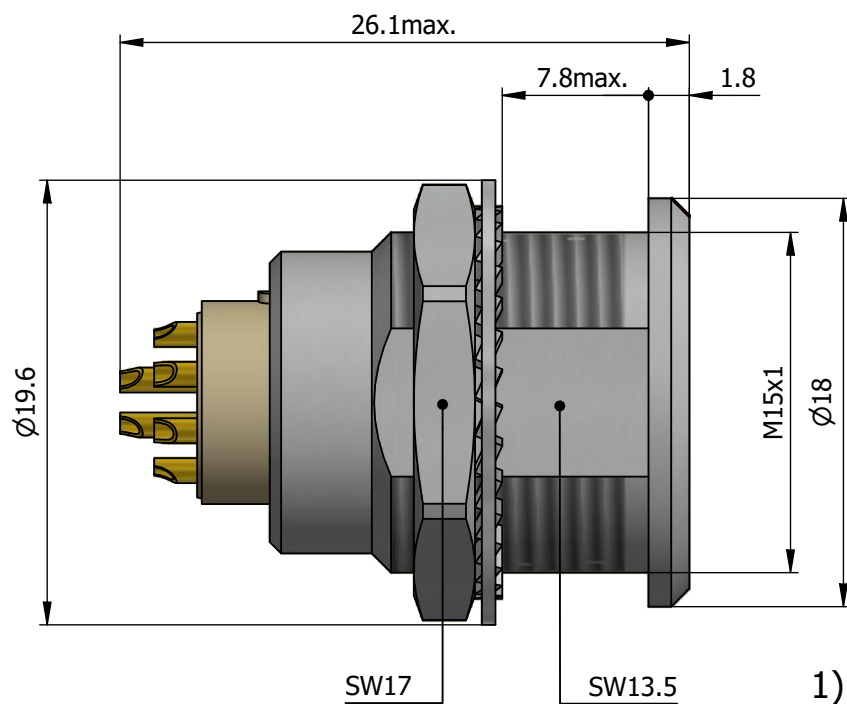

Insert Configuration
Rear View

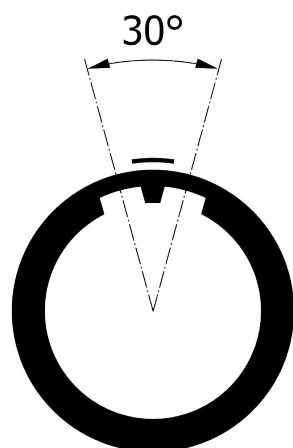
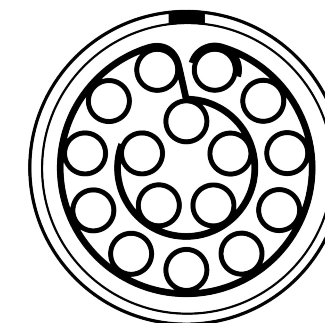

Recommended Panel Cut-Out

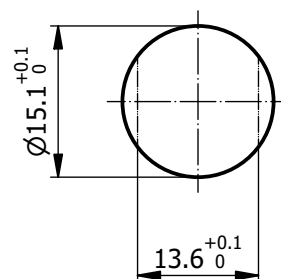

Mounting nut torque (Nm)
Metal shell = 6.0
Plastic shell = 0.8

Note:

1) This picture is generic and for illustrative purposes only, and may show different keying, materials, colour, finish, and contact configuration. Minor shape or feature variations to actual item may be present.

All additional information are documented on the datasheet (See below link or QR Code)
www.lemo.com/pdf/EGA.2B.316.CLL.pdf

Model Alignment Key Series Insert Config. Housing Insulator Contact Variant
EGA.2B.316.CLL

Datasheet



Fixed socket, nut fixing

Series 2B

LEMO
LEMO SA
Chemin des Champs-Courbes 28
1024 Ecublens - SWITZERLAND

Tel. (+41 21) 695 16 00
email : info@lemo.com
www.lemo.com

CD

Drawn	09.02.2022	MARI / MARI
Checked	09.02.2022	OBAR
Modified	00	09.02.2022 / MARI
DO NOT SCALE DRAWING		

EGA.2B.316.CLL